

> Virkon™
the science to
kill pathogens



**Protecting Against
African Swine Fever Virus
Breaching Our US Borders**





Protecting Against African Swine Fever Virus Breaching Our US Borders

On April 10, 2019 the National Pork Producers Council (NPPC) announced the cancellation of the 2019 World Pork Expo held each June at the Iowa State Fairgrounds in Des Moines. The event draws 20,000 visitors over three days including exhibitors and attendees from countries impacted by the current African Swine Fever virus (ASFv) outbreaks. David Herring NPPC president and North Carolina producer states, "...exercise extreme caution. The health of the U.S. swine herd is paramount; the livelihoods of our producers depend on it. Prevention is our only defense of ASFv, and NPPC will continue to do all it can to prevent its spread to the United States."



On March 15, 2019 U.S. Customs and Border Protection announced that federal agents confiscated 1 million pounds of pork smuggled into the port of Newark, New Jersey from China. The seizure of pork products, which entered the United States in 50 shipping containers is said to be the largest seizure of agriculture products in the U.S. It has been estimated that if ASFv was detected in the United States, over \$10 billion in estimated damage could occur in the first year. USDA is monitoring the recent outbreaks of ASFv in Asia and Europe and have proactively increased safeguarding efforts to keep the disease out of the U.S. including: working with U.S. Customs & Border Protection at ports of entry (cargo, passengers and products), increasing detector dog teams to search for illegal products, collaborate with state and industry producers to ensure strict biosecurity protocols, restrict imports of pork, coordinate on response plans to be ready and expand on testing capabilities in the U.S.

Both of these recent incidents help depict the seriousness and extreme economic loss ASFv could possibly bring to the United States.





Past & current outbreaks of ASFv

African Swine Fever virus—first described in Kenya in the 1920s—is a contagious hemorrhagic disease of wild and domestic pigs. Spain and Portugal eradicated ASFv in the mid-1990's; it was also eradicated from the Caribbean following outbreaks from 1977–1980. Since 2007 the disease has been reported in multiple countries across Africa, Asia and Europe. China confirmed the first case of ASFv back in August 2018 in their domestic swine population. Since then, approximately 1.1 million pigs have been culled in China. Vietnam has seen devastating loss culling at least 2.8 million pigs. The country of China has roughly 440 million pigs, which makes up more than half of all pigs on earth. The spread of ASFv has been devastating for small producers and businesses across the region creating extreme economic loss. ASFv is currently in several other neighboring countries as well such as: Mongolia, Russia, Cambodia, Hong Kong and North Korea as well as the European Union, reaching 10 member states such as Poland, Belgium and Romania. Implementing biosecurity best practices is essential in order to help reduce or eliminate the spread of the disease.

Nature of the disease

African Swine Fever virus is a highly contagious deadly disease found in domestic and wild pigs that exhibits virulence between strains and is resilient to physical and chemical inactivation. The causative agent of ASFv is a unique, enveloped, double-stranded DNA arbovirus which is the sole member of the family Asfarviridae. ASFv is a very resilient virus that can withstand low temperatures, fluctuations in pH from 3.9 pH to 11.5 pH and remain viable for long periods in blood, feces, tissues and bodily fluids. At the recent Allen D. Lemmon Swine Conference (September 2018 USA), Dr. C. Ora commented, that with more than 20 genotypes, many proteins – 60 to 180 (encoded) this is a highly complex virus. With the robust nature of the complex, multi-layered enveloped virus comes a far wider range of pH stability than with other enveloped viruses. In fact the pH range stability resembles behavior of non-enveloped viruses creating a strength of ASFv which makes developing a vaccine or treatment quite difficult. Additionally, although progress to date has been made on a vaccine the traditional approach to making a vaccine with dead virus is extremely difficult because ASFv produces additional proteins not present in the dead virus, which the host immune system is not able to recognize when exposed to the live virus. Because of these attributes, the primary control and eradication strategy is stamping-out. Stamping-out is the depopulation of clinically affected swine and, as appropriate, swine that are considered to be exposed to the virus. Finally, in planning, there is another good rule that should be adhered to at all times; never share anything between positive or negative units, be it via transport, personnel or equipment.



Transmission of the disease

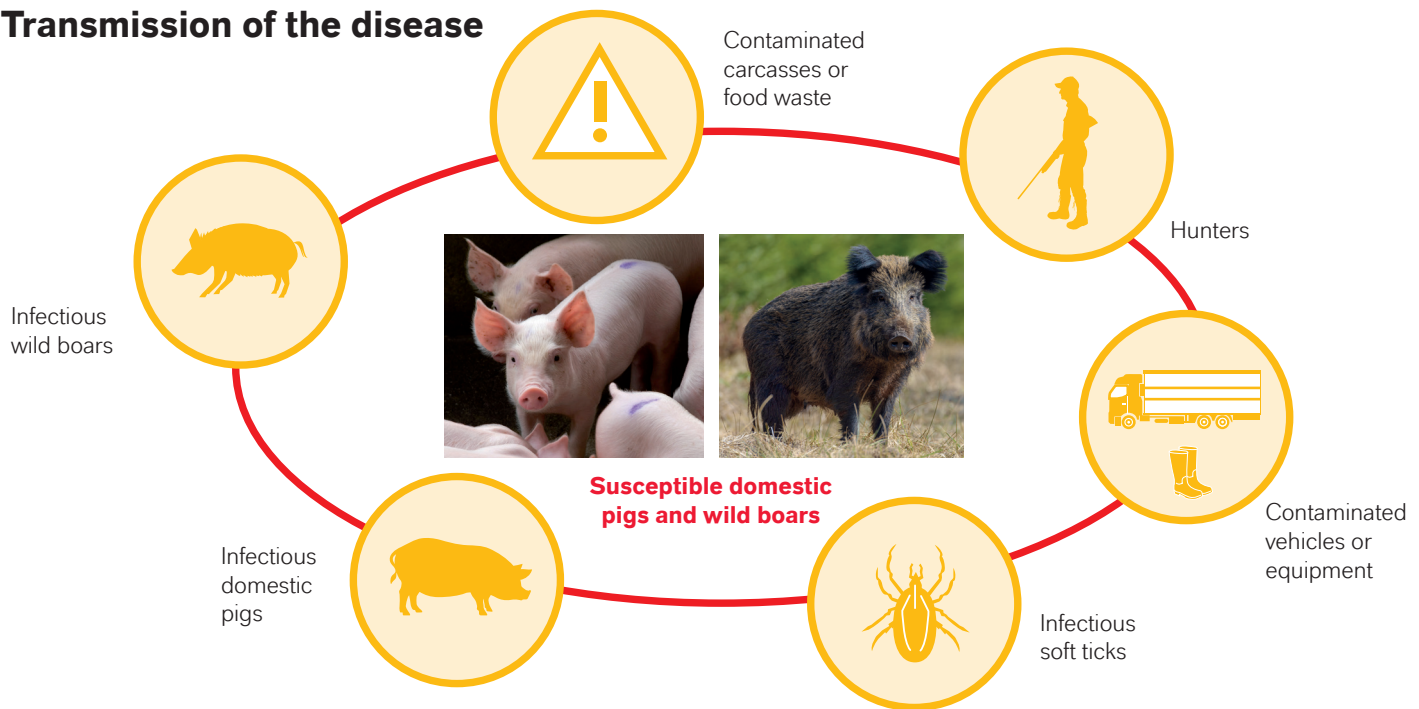

Pigs or wild boars typically become infected by direct contact with infected pigs (alive or dead), or by ingestion of garbage and/or food containing unprocessed infected pig products. The virus may persist in uncooked meat products for several months, and therefore could be transmitted via ingestion of contaminated pig feed, or meat products.

In addition, ASFv can be spread by pig transportation or service vehicles. Transmission can also occur via soft ticks, biting flies and non-living objects such as: clothes, shoes, vehicles, knives, equipment, etc., due to the high environmental resistance of the ASF virus. ASFv currently is not zoonotic and a threat to humans and cannot be transmitted from pigs to humans. However, humans can carry the virus on their belongings.

Those who hunt, both in the US or internationally should be mindful of coming into contact with affected wild boar and contracting the virus inadvertently through clothing, footwear or equipment.

Unfortunately, because the strain is so hardy it is very easy to spread ASFv without even knowing it. The ASF virus can typically survive on surfaces for days: cotton clothing (4 days), nose (1 day) and hair (3 days). It is essential to be aware of these potential vectors, and consider them when developing or updating your biosecurity plans.

Incubation period

The incubation period can vary from 3 to 21 days, based on the route of transmission.

Who do you contact to report suspected ASFv cases:

If your pigs show any of these symptoms report it immediately to your veterinarian, animal health officials or call USDA's toll-free number at **1-866-536-7593** for testing and investigation. Quick detection is essential for preventing the spread of ASFv.



Clinical symptoms:

- High fever
- Depression
- Diarrhea
- Vomiting
- Loss of appetite
- Red, blotchy skin or skin lesions
- Coughing or difficulty breathing
- Abortions
- Weakness
- Sudden death



Advanced biosecurity is the answer.

“What is Advanced Biosecurity?” As defined by the U.S. Department of Agriculture, “Biosecurity refers to all measures taken to keep diseases and pathogens that carry them – viruses, bacteria, fungi, parasites, and other micro-organisms – away from pigs, property, and people.” In order to protect your pigs, it is essential to put into place strong biosecurity practices that are maintained and constant – all day, every day. For biosecurity to be effective against ASF there must be good planning, procedures and training put into place.

Planning

Thoroughly review your biosecurity plans at all levels using a risk-based approach involving your veterinarian, management team and farm staff. No biosecurity plan? Develop one and begin following it.

Begin with transportation, scheduling is vital; breeding herds should preferably have dedicated transport. Ensure you have different transport vehicles for infected and virus free farms. Personnel movement is another target area: advisers, management and farm staff are all increased risks as they move between farms. Make sure anyone who visits your farm – workers or visitors – are aware of and follow all components of your biosecurity protocol. If visitors are unfamiliar with your biosecurity procedures, train individuals before allowing them access onto the farm. Delivery and entry of equipment needs planning, as do removal of dead pigs, manure and any other waste. Control of wild boar/pigs, rodents and other animals should be reviewed. Ensure a secured perimeter barrier or fence is in place to stop large animals such as wild boar/pigs, deer, foxes etc. from entering the site.

Additionally, never share anything between positive or negative farms, be it transport vehicles, personnel or equipment.

Know who & what is on your farm

- ▶ Pay close attention to the foot or vehicle traffic coming onto and off of your farm. Try to limit on-farm traffic as much as possible.
- ▶ Set up and maintain a detailed log of all the people, vehicles, and equipment currently on your farm or other pig production facilities.
- ▶ Clean and disinfect all equipment and vehicles entering or leaving your site.
- ▶ Isolate sick pigs from the herd, and keep them away from visitors.
- ▶ Ask visitors about recent international travel. Don't let anyone who has been in an ASF affected country onto your farm for at least five days after returning to the United States.
- ▶ Make sure visitors wear clean clothes and shoes at all pig production facilities and farms.

Procedures

One of the most important aspects of biosecurity is the understanding and use of lines of separation between clean and dirty areas. This has to happen throughout the production system. For example, between the loading chute and pig transporter, between the dirty and clean sides in a Danish entry system (shown below), or between the ground and the cab of a feed delivery vehicle. All the relevant lines of separation have to be identified, and correct procedures for achieving separation established and used. There are many other procedures that need full compliance. These include



such things as: correct use of shower facilities, correct procedures for leaving and re-entering the farm, disinfection of equipment arriving at the farm, disinfection after risk vehicles have been near the farm, and contractor and staff behavior during manure hauling. In an infected farm, where bio-containment is being practiced, examples of procedures are: control of staff movement around the farm, cleaning and disinfection of walkways after pig movement, correct local manure removal and flushing, and high level terminal cleaning and disinfection between batches.

Training

Buy-in and training is an integral part of any biosecurity program. This must include management, farm staff, drivers, service personnel and visitors. To drive full compliance they need to clearly understand why biosecurity against ASFv is so important and how easily the virus can spread.

Biosecurity coordinators must make it a priority to train, review and retrain as needed. One challenge is high staff turnover and the need to keep up to date. Compliance is everything, and failure to comply will lead to a biosecurity breach sooner or later.

Practice Biosecurity Regularly

The Danish Entry System is an easy to use biosecurity tool that can greatly help reduce the spread of disease-causing organisms such as African Swine Fever virus (ASFv) from being introduced to, or spreading from, a pig shed/barn.

The key to the Danish Entry System:

- a biosecure entrance to the pig shed/barn
- the entrance area of the shed/barn has separate clean and dirty areas divided by a physical barrier, usually a small dwarf wall or standup shower system.
- upon entry to the building you will be in the “dirty” area where you will be required to:
 - disinfect footwear using a disinfection boot bath
 - remove outer clothing and footwear
 - wash and disinfect hands or shower in & out completely (with shampoo and soap)
 - move to the clean area, on the other side of the barrier, where clean protective clothing, such as boots and coveralls, are provided (boots should be put on before coveralls)
 - Disinfect boots using the disinfectant boot bath provided, and then enter the production area
- The protocol is completed in reverse when exiting the building.



DANISH ENTRY SYSTEM FLOW

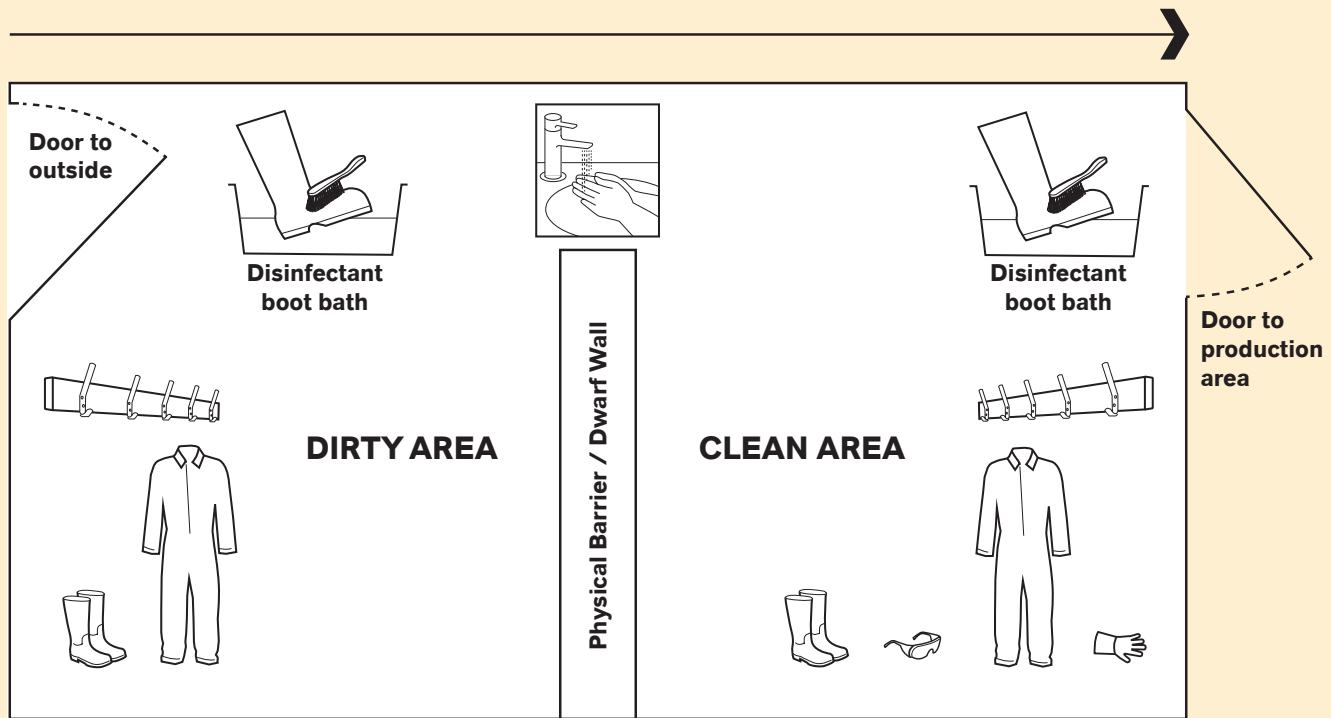

Clean and Disinfect Program:

To achieve the appropriate use-diluted Virkon™ S concentration, fill container with the volume of water and quantity of powder or tablet(s) found in the following table. Stir thoroughly until fully dissolved, then use.



Virkon™ S Powder:

Quantity of water	0.5% Solution ^{††}	1% Solution	2% Solution
1 Quart	0.15 ounces	0.3 ounces	0.7 ounces
1 Gallon	0.65 ounces [1/2 Scoop]	1.3 ounces [1 Scoop]	2.7 ounces [2 Scoops]
10 Gallons	0.15 ounces [5 Scoops]	13.4 ounces [10 Scoops]	26.7 ounces [20 Scoops]
50 Gallons	0.15 ounces [25 Scoops]	66.8 ounces [50 Scoops]	133.5 ounces [100 Scoops]

Measuring cup provided. [1 Scoop = 1.3 ounces] [1 measuring cup = 1 scoop = 1.3 oz.]

How to make a ready-to-use Virkon™ S disinfectant solution:

STEP 1

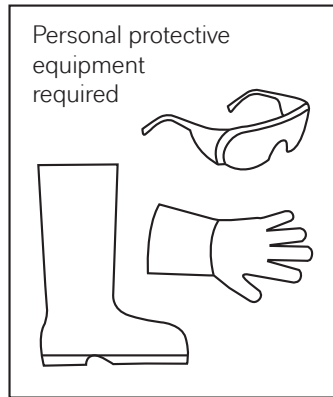

STEP 2

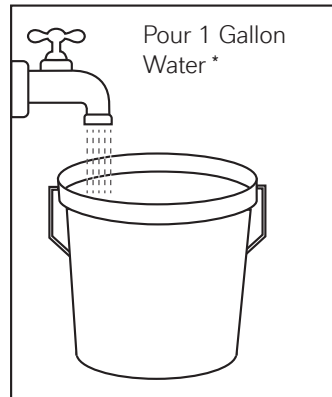

STEP 3

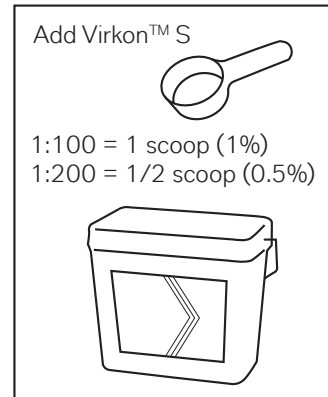

STEP 4

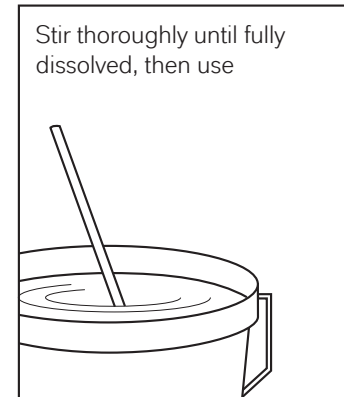

Measuring cup provided. 1 scoop = 1.3oz, 1/2 scoop = 0.65oz.
The 0.5% solution currently is not approved for use in California.

Virkon™ S Tablets:

Quantity of water	0.5% Solution**	1% Solution	2% Solution
1 Pint	–	1 tablet	2 tablets
1 Quart	1 tablet	2 tablets	4 tablets
1 Gallon	4 tablets	8 tablets	16 tablets

STEP 1

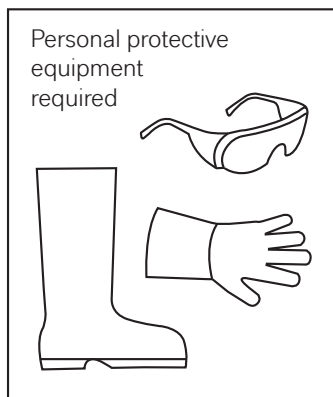

STEP 2

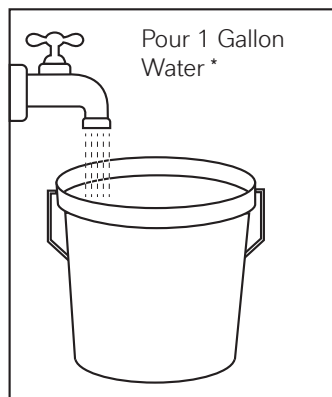

STEP 3

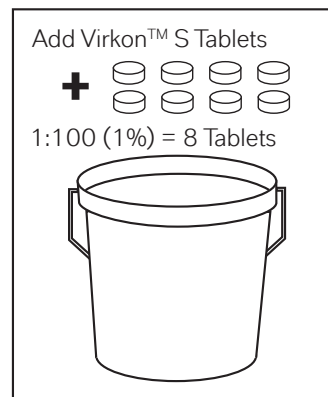

STEP 4

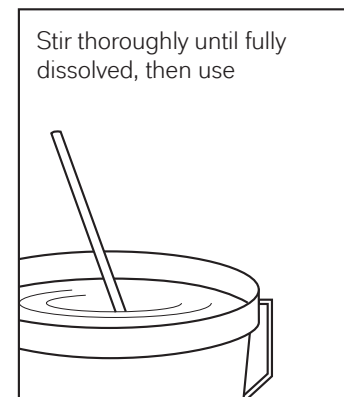

* The 0.5% solution currently is not approved for use in California.

Solutions are stable for 7 days. Do not soak metal objects in Virkon™ S for long periods – 10 minutes is maximum necessary contact time. One gallon of solution is sufficient to treat 135 sq.ft.



How to Make a Concentrated Stock Solution of Virkon™ S

This powder formulation is easily diluted for use in manual or machine operations. Please see instructions below for mixing a concentrated Virkon™ S stock solution to be used in a Hydrofoamer 481.

Using the Hydrofoamer 481 (96oz.)* – How to Make a Concentrated Stock Solution

10lb Pail of Virkon™ S =160 oz.

Dilution Factor (DF)	Hydrofoamer Tip color	1:100 Dilution Rate (1.3 oz./gal)
Calculation		$\text{_oz.} = 1.3\text{oz} \times \text{DF} \times \text{Volume of sprayer in gallons}$ $\text{\# of scoops} = \text{oz. Virkon™ S} / 1.3 \text{ oz.}$
12:1	No tip	11.7 oz Virkon™ S 9 scoops of Virkon™ S
14:1	White	13.65 oz Virkon™ S 10.5 scoops of Virkon™ S
16:1	Blue	15.6 oz Virkon™ S 12 scoops Virkon™ S
18:1	Tan	N/A
32:1	Orange	N/A
64:1	Purple	N/A

A Virkon™ S 1:100 solution would be highly concentrated at ratios above 16:1 (not fully soluble), denoted as N/A.



Convert your Hydrofoamer from ounces to gallons:

32 oz = 0.25 gallon

96 oz = 0.75 gallon

64 oz = 0.5 gallon

128 oz = 1 gallon

*-Not approved for this use in California

virkon.com

Boot Disinfection

Virkon™ S at 1% solution can be used for cleaning and disinfecting boots**.



Boot bath and tray:

Place boot bath or tray at entrances to prevent cross contamination from area to area.



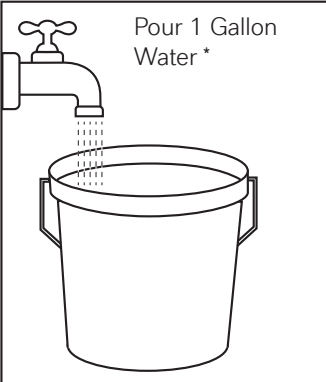
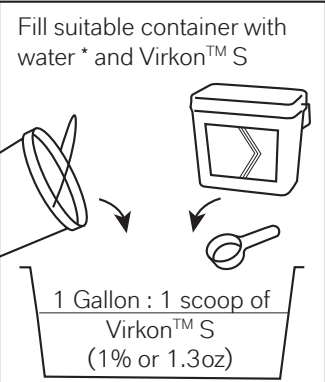

- Make a 1% solution of Virkon™ S by filling a suitable container with water and Virkon™ S according to the dilution table. Stir thoroughly until fully dissolved. Change the solution every 2 to 3 days or when it becomes visibly soiled.
- Before application of Virkon™ S solution, rinse or brush footwear surfaces, including soles, to remove gross filth and heavy soil deposits.
- Step into the container with boots on and use a clean brush to clean boots with disinfectant solution.
- Wash boots thoroughly paying close attention to the soles. Surface contact time is 10 minutes.

** Virkon™ S should only be used on water proof or non-porous footwear. Do not use on footwear that is damaged or permeable by water.

How to make a Virkon™ S disinfectant boot bath

STEP 1  <p>Pour 1 Gallon Water *</p>	STEP 2  <p>Fill suitable container with water * and Virkon™ S</p> <p>1 Gallon : 1 scoop of Virkon™ S (1% or 1.3oz)</p>	STEP 3  <p>Stir thoroughly until fully dissolved</p>	STEP 4  <p>Provide 2 brushes for cleaning</p>
---	---	--	--

How to disinfect rubber boots using Virkon™ S:

STEP 5  <p>Remove visible organic matter from boots and soles</p>	STEP 6  <p>Step into the boot bath and use the second brush to clean boots with disinfectant solution</p>	STEP 7  <p>Wash boots thoroughly paying close attention to the soles. Surface contact time is 10 minutes</p>	STEP 8  <p>Refresh solution daily or more frequently if the solution becomes visibly soiled</p>
--	--	--	--

Virkon™ S in-use solutions can be used for:

BARN SURFACES

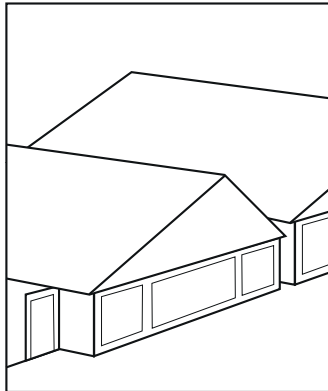

MOVABLE EQUIPMENT

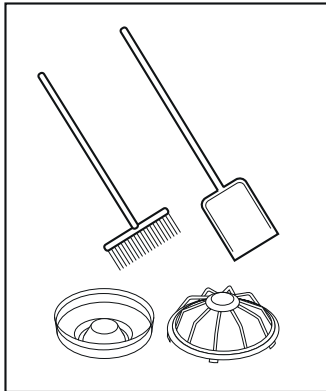

BOOTS & FOOTWEAR

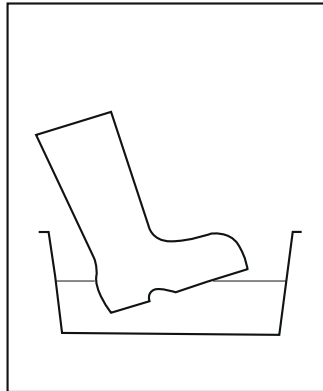

VEHICLES

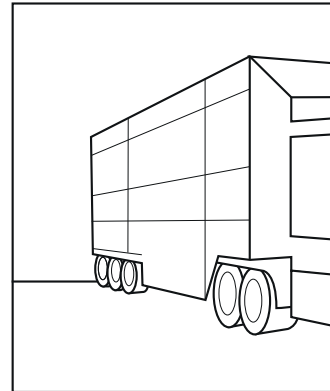

SWINE STALL

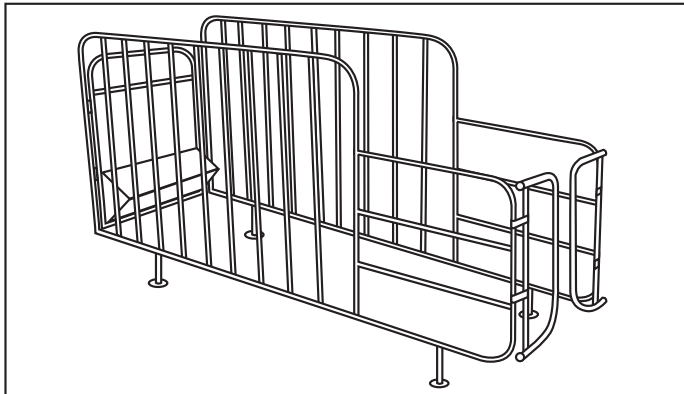

Swine Production Biosecurity Program Parameters

1. Establish a secure perimeter to ensure that the site is limited to one combined entrance and exit.
2. Put a shower-in policy in place and provide handwashing facilities.
3. Minimize the number of visitors and, where possible, provide “farm only” boots and overalls.
4. Clean vehicle wheels and personnel rubber boots with Virkon™ S as per product container label directions.
5. Ensure that all vehicles have been thoroughly cleaned and disinfected prior to arrival at site. Limit the amount of essential vehicles entering or exiting the site.

Swine Production Disinfection

1. Follow general instructions from Virkon™ S product container label to remove swine and pre-clean area to be treated.
2. Use a 1% solution of Virkon™ S for cleaning and disinfecting farrowing units, nurseries, finisher houses, processing plants, and agricultural production equipment such as trucks, waterproof footwear (such as rubber boots), and associated livestock equipment and instruments.
3. Saturate surfaces with a 1% solution of Virkon™ S with a cloth, mop, mechanical spray, or sponge for a period of 10 minutes.
4. Allow surfaces to air dry.
5. Rinse waterers and feeders with potable water before reuse.

virkon.com

Virkon™

S

Powerful Broad Spectrum
Virucidal Disinfectant



References:

<https://www.nationalhogfarmer.com/livestock/2019-world-pork-expo-cancelled>

http://www.agrinenews-pubs.com/news/people-pork-and-feed-top-list-of-asf-threats/article_6b99a463-237c-521c-ba4b-76839980a431.html

www.aphis.usda.gov

<http://www.fao.org/ag/againfo/programmes/en/empres/ASF/Virology.html>

<http://www.oie.int/en/animal-health-in-the-world/animal-diseases/african-swine-fever/>

<https://www.vox.com/2019/6/6/18655460/china-african-swine-fever-pig-ebola>

https://www.washingtonpost.com/world/asia_pacific/millions-of-pigs-culled-as-swine-fever-spreads-through-asia/2019/06/21/d6625a18-93df-11e9-956a-88c291ab5c38_story.html?noredirect=on&utm_term=.28cfeb6f0acc

https://www.washingtonpost.com/world/asia_pacific/as-swine-fever-spreads-asian-countries-cull-millions-of-pigs/2019/06/28/d507d6bc-984d-11e9-9a16-dc551ea5a43b_story.html?utm_term=.fb024a2dd4c2

Health and Safety Information: Appropriate literature has been assembled which provides information concerning the health and safety precautions that must be observed when handling the LANXESS products mentioned in this publication. For materials mentioned which are not LANXESS products, appropriate industrial hygiene and other safety precautions recommended by their manufacturers should be followed. Before working with any of these products, you must read and become familiar with the available information on their hazards, proper use, and handling. This cannot be overemphasized. Information is available in several forms, e.g., material safety data sheets and product labels. Consult your LANXESS Corporation representative or contact the Product Safety and Regulatory Affairs Department at LANXESS.

LANXESS Corporation

111 RIDC Park West Drive • Pittsburgh, PA 15275 • Phone: 1-800-LANXESS • www.US.LANXESS.com

The manner in which you use and the purpose to which you put and utilize our products, technical assistance and information (whether verbal, written or by way of production evaluations), including any suggested formulations and recommendations are beyond our control. Therefore, it is imperative that you test our products, technical assistance and information to determine to your own satisfaction whether they are suitable for your intended uses and applications. This application-specific analysis must at least include testing to determine suitability from a technical as well as health, safety, and environmental standpoint. Such testing has not necessarily been done by us. Unless we otherwise agree in writing, all products are sold strictly pursuant to the terms of our standard conditions of sale. All information and technical assistance is given without warranty or guarantee and is subject to change without notice. It is expressly understood and agreed that you assume and hereby expressly release us from all liability, in tort, contract or otherwise, incurred in connection with the use of our products, technical assistance, and information. Any statement or recommendation not contained herein is unauthorized and shall not bind us. Nothing herein shall be construed as a recommendation to use any product in conflict with patents covering any material or its use. No license is implied or in fact granted under the claims of any patent.

Note: The information contained in this publication is current as of July, 2019. Please contact LANXESS Corporation to determine if this publication has been revised.

©2019 LANXESS. Virkon™, LANXESS™, the LANXESS Logo and any associated logos are trademarks or copyrights of LANXESS Deutschland GmbH or its affiliates. All trademarks are registered in many countries worldwide.

Learn more at virkon.us/

Page 12 of 12: This document contains important information and must be read in its entirety.
LANXESS/ Virkon™ S /ASF brochure/US/18.07.19/G

LANXESS
Energizing Chemistry